

MODEL 1530 SIDE VIEW

SCALE: NTS

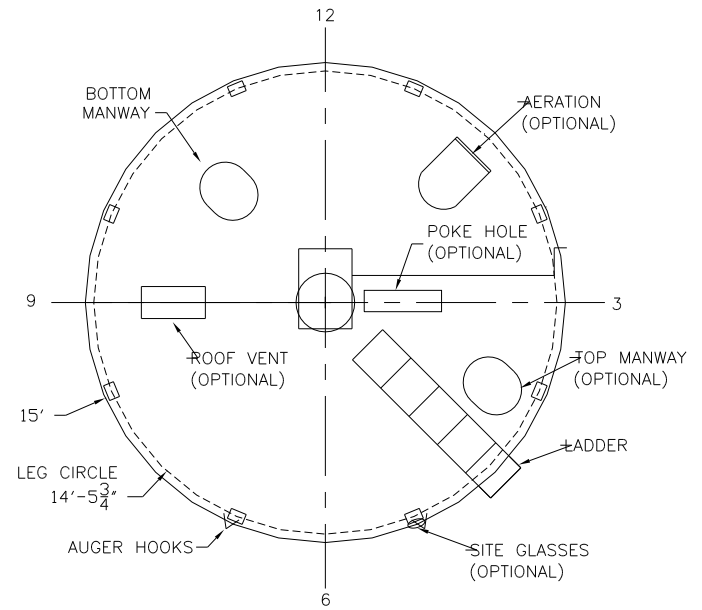

ACCESSORIES LOCATIONS

SCALE: NTS

AMBER WAVES, INC. RICHARDTON, ND PH 701-974-4230 FAX 701-974-4231	
15 FT DIA BIN MODEL 1530 SIDE VIEW	
DRAWN: JAH CHK'D: DATE: 9/19/02 SCALE: NTS	SHEET NUMBER 1530
JOB NUMBER	REVISION NUMBER 0